



Simply Showers
Hardware Supplies

Simply Showers...

Bohle presents a simple overview to our extensive range of shower hardware, offering hinges and fittings to suit every pocket. Divided into Basic, Select and Premium product groups, we offer reliable, high quality hardware in a range of price options. This straightforward guide will offer you options for the construction of the most popular shower configurations, including hinges, reinforcement bars, clamps, handles and sealing strips. To find out more about our comprehensive range please contact our friendly and knowledgeable Customer Services staff, who are more than happy to help you with your enquiries, or visit our website www.bohle-group.com.

"Fittings for glass"

Discover the World of Bohle Hardware

The new high impact duo for your hardware projects: The Design Manual with its large application images is perfectly suited for choosing the suitable fittings together with your customers. The Planning Manual contains all technical data and forms the basis for quickly and easily calculating and implementing your projects and orders with Bohle products.

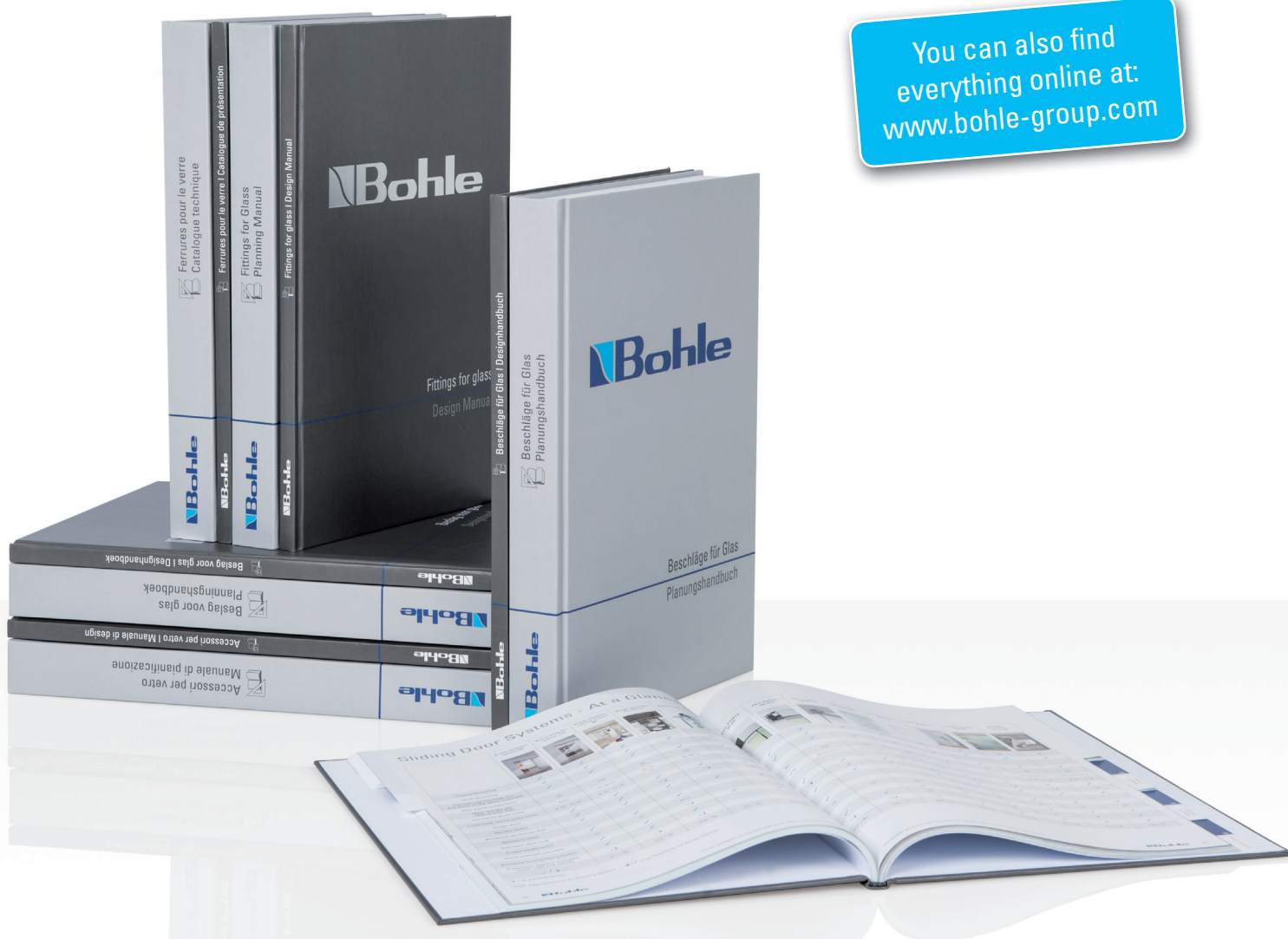





Index

01	Shower Door Hinges Overview	4
02	Barcelona Shower Door Hinges	6
03	Bilbao Shower Door Hinges	7
04	Europe Shower Door Hinges	8
05	Barcelona Select Shower Door Hinges	9
06	Bilbao Select Shower Door Hinges	10
07	Granada Shower Door Hinges	11
08	Bilbao Premium Shower Door Hinges	12
09	Aqua Shower Door Hinges	13
10	Profiles for Glass Partitions	14
11	Transparent Setting and Distance Blocks and Duplocoll®	15
12	Sealing Strips	16
13	Thresholds	22
14	Basic round Reinforcement Bars	23
15	Premium round Reinforcement Bars	24
16	Basic square Reinforcement Bars	25
17	Premium square Reinforcement Bars	26
18	Doorknobs, Handles and Towel Holders for Showers	27
19	BriteGuard®	30
20	Limescale Remover	33
21	Ways to contact us	35

Shower Door Hinges

ShowerTec® Basic	Barcelona	Bilbao
		
Swinging Shower Door Hinge	✓	✓
Shower Door Hinge for one-side opening doors, continuous sealing strip		
Flush on the inner side		
Rise and fall mechanism		
Adjustment of zero position		
Drill holes in glass		
Glass cut-out	✓	✓
Glass thickness tempered glass (mm)	8 / 10 / 12	8 / 10 / 12
Maximum door weight (kg)	35	35
Glass size (mm)	700 x 2000	700 x 2000

ShowerTec® Select	Europe	Barcelona Select	Bilbao Select	Granada
				
Swinging Shower Door Hinge	✓	✓	✓	✓
Shower Door Hinge for one-side opening doors, continuous sealing strip				
Flush on the inner side				
Rise and fall mechanism				
Adjustment of zero position	✓	✓	✓	✓
Drill holes in glass				
Glass cut-out	✓	✓	✓	✓
Glass thickness tempered glass (mm)	8 / 10	8 / 10 / 12	8 / 10 / 12	8 / 10
Maximum door weight (kg)	40	35	35	35
Glass size (mm)	1000 x 2000	700 x 2000	700 x 2000	790 x 2000

<h1>ShowerTec® Premium</h1>	Bilbao
	
Swinging Shower Door Hinge	✓
Shower Door Hinge for one-side opening doors, continuous sealing strip	
Flush on the inner side	
Rise and fall mechanism	
Adjustment of zero position	✓
Drill holes in glass	
Glass cut-out	✓
Glass thickness tempered glass (mm)	8 / 10 / 12
Maximum door weight (kg)	36 / 50
Glass size (mm)	700 x 2000 / 1000 x 2000

"Handling Technology"
**New Catalogue - Even
 Better Overview**

You haven't yet received our catalogue? Download it at www.bohle-group.com.





Whatever you would like to lift, carry or fix - Bohle offers you the suitable handling device. Our extensive product portfolio is subdivided into the following divisions:

- 01 Handling with vacuum
- 02 Handling without vacuum
- 03 Handling devices
- 04 Fixing aids
- 05 Protective equipment

Bohle offers the appropriate product for any requirement. If you have any questions, our competent team is happy to assist you!

Barcelona Shower Door Hinges

Shower door hinges made of brass, suitable for 8, 10 or 12 mm glass. The hinges have an automatic return motion of $\sim \pm 15^\circ$ to zero position. Outside this automatic return range, the hinges remain in any set position. Maximum door weight: 35 kg, maximum door width: 700 mm
To see the full range of Barcelona fittings visit www.bohle-group.com, or phone 0800 616151 for a full Fittings for Glass catalogue.



Shower Door Hinge	chrome-plated	stainless steel look
 90° glass/wall, one side wall mounted	BO 5218110	BO 5218111
 90° glass/wall, both sides wall mounted	BO 5219010	BO 5219011
 180° glass/glass	BO 5219210	BO 5219211

Corner Clamp Barcelona	chrome-plated	stainless steel look
 90° glass/wall	BO 5200095	
 90° glass/glass	BO 5200097	
 90° glass/wall	BO 5219080	BO 5219081
 90° glass/glass	BO 5219060	BO 5219061
Connector Barcelona	chrome-plated	stainless steel look
 90° glass/wall	BO 5219050	BO 5219051



Bilbao Shower Door Hinges

Shower door hinges made of brass, suitable for 8, 10 or 12 mm glass. The hinges have an automatic return motion of $\sim \pm 15^\circ$ to zero position. Outside this automatic return range, the hinges remain in any set position. Maximum door weight: 35 kg, maximum door width: 700 mm. To see the full range of Bilbao fittings visit www.bohle-group.com, or phone 0800 616151 for a full Fittings for Glass catalogue.

Shower Door Hinge Bilbao	chrome-plated	stainless steel look
 90° glass/wall, one side wall mounted	BO 5211549	BO 5211550
 90° glass/wall, large mounting plate, both sides wall mounted	BO 5218010	BO 5218011
 180° glass/glass	BO 5218210	BO 5218211

Corner Clamp Bilbao	chrome-plated	stainless steel look
 90° glass/glass	BO 5213130	
 90° glass/wall	BO 5213120	
Connector Bilbao	chrome-plated	stainless steel look
 90° glass/wall	BO 5218420	BO 5218421
 90° glass/wall	BO 5218430	BO 5218431



Europe Shower Door Hinges

The Europe series of shower door hinges was developed by Bohle, taking both functionality and aesthetics into account. This product range has a timeless design which fits perfectly in modern bathrooms. The zero position is individually adjustable by +/- 5° and can easily be reset at any time. The Europe series is suitable for 8 or 10 mm glass and door weights up to 40 kg with a maximum door width: of 1000 mm (for 8 mm glass).





Shower Door Hinge Europe		chrome-plated	matt chrome-plated	stainless steel look
	90° glass/wall, one side wall mounted	BO 5400001	BO 5400002	
	90° glass/wall, both sides wall mounted	BO 5400011	BO 5400012	BO 5400010
	180° glass/glass aligned	BO 5400021	BO 5400022	BO 5400020
Corner Clamp Europe		chrome-plated	matt chrome-plated	stainless steel look
	90° glass/wall	BO 5400071	BO 5400072	BO 5400070
	90° glass/glass	BO 5400081	BO 5400082	BO 5400080
Connector Europe		chrome-plated	matt chrome-plated	stainless steel look
	90° glass/wall	BO 5400061	BO 5400062	BO 5400060





Barcelona Select Shower Door Hinges

Shower door hinges made of brass, suitable for 8, 10 or 12 mm glass. The hinges have an automatic return motion of $\sim \pm 15^\circ$ to zero position. Outside this automatic return range, the hinges remain in any set position. Maximum door weight: 35 kg · maximum door width: 700 mm. The zero position is adjustable.

To see the full range of Barcelona Select fittings visit www.bohle-group.com, or phone 0800 616151 for a full Fittings for Glass catalogue.

Shower Door Hinge	chrome-plated	stainless steel look
 90° (adjustable) one side wall mounted	BO 5219110	BO 5219111
 90° (adjustable) both sides wall mounted	BO 5219114	BO 5219115
 90° glass/wall, divided mounting plate, both sides wall mounted	BO 5219130	BO 5219131
 180° (adjustable) glass/glass	BO 5219118	BO 5219119

Corner Clamp	chrome-plated	stainless steel look
 90° glass/wall	BO 5200095	
 90° glass/glass	BO 5200097	
 90° glass/wall	BO 5219080	BO 5219081
 90° glass/glass	BO 5219060	BO 5219061



Bilbao Select Shower Door Hinges

Shower door hinges made of brass, suitable for 8, 10 or 12 mm glass. The hinges have an automatic return motion of $\sim \pm 15^\circ$ to zero position. Outside this automatic return range, the hinges remain in any set position. Maximum door weight: 35 kg, maximum door width: 700 mm. The zero position is adjustable.

To see the full range of Bilbao Select fittings visit www.bohle-group.com, or phone 0800 616151 for a full Fittings for Glass catalogue.

Shower Door Hinge	chrome-plated	stainless steel look
 90° (adjustable) one side wall mounted	BO 5211546	BO 5211547
 90° (adjustable) both sides wall mounted	BO 5211516	BO 5211517
 180° (adjustable) glass/glass	BO 5211716	BO 5211717
Corner Clamp	chrome-plated	stainless steel look
 90° glass/glass	BO 5213150	BO 5213151
 90° glass/wall	BO 5213140	BO 5213141



Granada Shower Door Hinges

Shower door hinges made of brass, suitable for 8 or 10 mm glass. The hinges have an automatic return motion of $\sim \pm 15^\circ$ to zero position. Outside this automatic return range, the hinges remain in any set position. Maximum door weight: 35 kg, maximum door width: 790 mm · with adjustable zero position.

To see the full range of Granada fittings visit www.bohle-group.com, or phone 0800 616151 for a full Fittings for Glass catalogue.



Shower Door Hinge Granada		chrome-plated	stainless steel look
	90° glass/wall, one side wall mounted	BO 5214058	BO 5214046
	90° glass/wall, both sides wall mounted	BO 5214050	BO 5214045
	180° glass/glass	BO 5214052	BO 5214047
Corner Clamp Granada		chrome-plated	stainless steel look
	90° glass/glass	BO 5213622	
	90° glass/wall	BO 5213116	
Connector Granada		chrome-plated	stainless steel look
	90° glass/wall	BO 5213606	BO 5213605



Bilbao Premium Shower Door Hinges

Shower door hinges made of brass, suitable for 8, 10 or 12 mm glass. The hinges have an automatic return motion of $\sim \pm 15^\circ$ to zero position. Outside this automatic return range, the hinges remain in any set position. Maximum door weight: 36/50 kg, maximum door width: 700/1000 mm · with adjustable zero position.

To see the full range of Bilbao Premium fittings visit www.bohle-group.com, or phone 0800 616151 for a full Fittings for Glass catalogue.

Shower Door Hinge	chrome-plated 36 kg	stainless steel look - 36 kg	chrome-plated 50 kg	stainless steel look - 50 kg
 90° (adjustable) one side wall mounted	BO 5211553	BO 5211554	BO 5211563	BO 5211564
 90° (adjustable) both side wall mounted	BO 5211551	BO 5211552	BO 5211561	BO 5211562
Corner Clamp	chrome-plated	stainless steel look	chrome-plated	stainless steel look
 90° one side wall mounted	BO 5211569	BO 5211570	BO 5211567	BO 5211568



Aqua Shower Door Hinges

Hold position both sides 90 ° · Length 2200 mm · Material Aluminium · Application glass/wall, glass/glass · Projection 800 mm · with Rise and fall mechanism · Zero position: infinitely adjustable

To see the full Aqua fittings range visit www.bohle-group.com, or phone 0800 616151 for a full Fittings for Glass catalogue.



Art. No.	Glass thickness - Finish
BO 5200405	6 mm - anodised aluminium EV1
BO 5200406	6 mm - polished
BO 5200407	8 mm - anodised aluminium EV1
BO 5200408	8 mm - polished
BO 5200409	Aqua Fixed Sidelight for 6 mm - anodised aluminium EV1
BO 5200410	Aqua Fixed Sidelight for 6 mm - polished
BO 5200416	Aqua Fixed Sidelight for 8 mm - anodised aluminium EV1
BO 5200417	Aqua Fixed Sidelight for 8 mm - polished



Profiles for Glass Partitions

Aluminium u-channels in 2150 mm, 2500 mm, 3650 mm and 5000 mm lengths for various glass thicknesses. Available in polished anodised, anodised and stainless steel look finishes. We also have a range of profiles for glass partitions, and mirror profiles for fitting 6 mm mirrors singly or as a complete wall to sound walls or other materials suitable for the intended load.

Bohle U-Channels



For installing fixed glass partitions · with radius corners · drilling guide in the bottom of the profile

i Length 3650 mm · Glass thickness 8 mm · Material Aluminium

Art. No.	Finish
BO 6703415	polished anodised
BO 6703416	anodised

Bohle U-Channels



For installing fixed glass partitions · with radius corners · drilling guide in the bottom of the profile

i Length 3650 mm · Glass thickness 10 mm · Material Aluminium

Art. No.	Finish
BO 6703420	polished anodised
BO 6703421	anodised
BO 6703422	stainless steel look

Bohle U-Channels

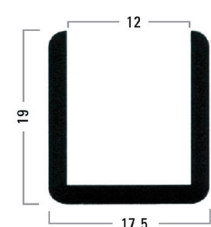

For installing fixed glass partitions · with radius corners · drilling guide in the bottom of the profile

i Length 3650 mm · Glass thickness 12 mm · Material Aluminium

Art. No.	Finish
BO 6703440	polished anodised

Bohle U-Channels

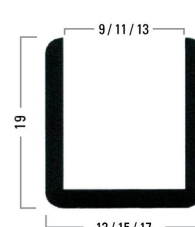

For installing fixed glass partitions · with radius corners · drilling guide in the bottom of the profile

i Length 2500 mm · Material Aluminium

Art. No.	Finish · Glass thickness
BO 6703430	polished anodised · 8 mm
BO 6703431	polished anodised · 10 mm
BO 6703432	stainless steel look · 10 mm
BO 6703433	polished anodised · 12 mm

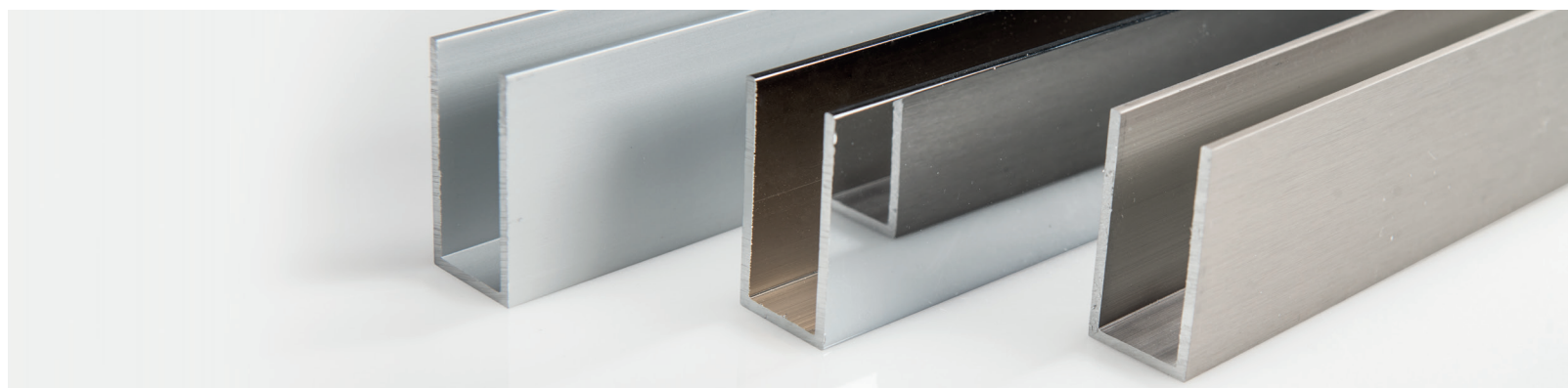

Transparent Setting and Distance Blocks and Duplocoll®

Bohle Transparent Setting and Distance Blocks



Transparent setting blocks made of plastic - for use when mounting all-glass showers, all-glass assemblies, mirrors or other glazing applications

Art. No.	Description
BO 5121001	50 mm x 6 mm x 1 mm, 100 per bag
BO 5121002	50 mm x 6 mm x 2 mm, 100 per bag
BO 5121003	50 mm x 6 mm x 3 mm, 100 per bag
BO 5121004	50 mm x 6 mm x 4 mm, 100 per bag
BO 5121005	50 mm x 6 mm x 5 mm, 100 per bag
BO 5121006	50 mm x 6 mm x 6 mm, 100 per bag
BO 5121008	50 mm x 6 mm x 8 mm, 100 per bag
BO 5121010	50 mm x 6 mm x 10 mm, 100 per bag
BO 5121011	Set of 25 blocks of each size, bag of 200

Also available in 5 m rolls!
You choose the length of the setting blocks!

Art. No.	Description
BO 5121002R	6 mm x 2 mm x 5 mtrs
BO 5121003R	6 mm x 3 mm x 5 mtrs
BO 5121004R	6 mm x 4 mm x 5 mtrs

Bohle Adhesive Bonding Tapes Bohle Duplocoll®

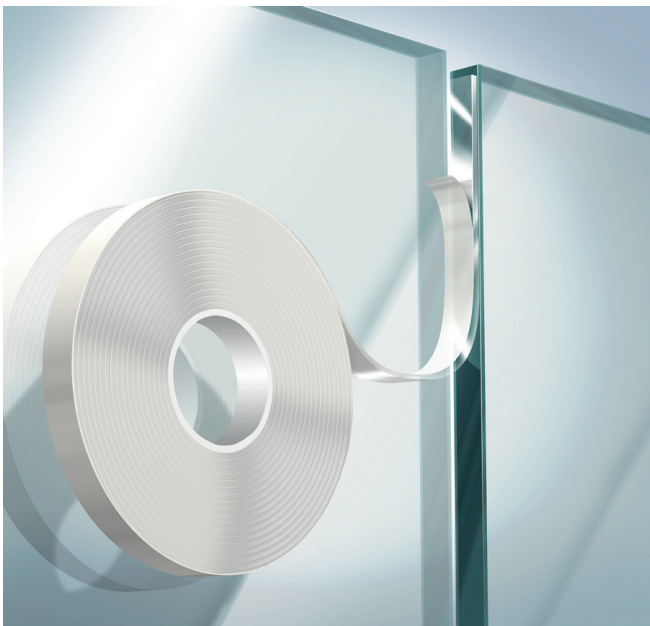

- For different applications, such as all-glass partition walls, furniture, shower cubicles and much more
- For different materials, such as wood, aluminium, plastic, ceramic or glass
- High transparency due to a light refractive index almost identical to glass
- Antimicrobial effect - inhibits growth of microorganisms
- By sealing the edges of the adhesive tape, Duplocoll® becomes dry after adhesion and resistant to external influences
- Elongation of up to 500% and highly split-resistant
- Resistant to chemicals and softeners
- Very good initial tack, lasting ultimate bonding strength
- Also suitable for rough surfaces: The viscoelastic adhesive film distributes evenly across rough surfaces.
- Resistant to ageing and UV radiation, economic, high quality and does not affect the external appearance of the construction

Thickness 3 mm · Colour transparent · Roll length 12 m · Max. allowable continuous temperature: -40°C - +100°C

Please note: Please use the corresponding applicator to ensure simple and precise application on the glass edge.

Art. No.	Width · Glass thickness
BO 5207936	5 mm · 8 mm
BO 5207938	7 mm · 10 mm
BO 5207935	9 mm · 12 - 12.7 mm

Art. No.	Description · Glass thickness
BO 5207939	Applicator · 8, 10 mm
BO 5207948	Inlay for BO 5207939 · 10, 12 mm
BO 5207946	Applicator · 10.76; 12.7; 12.76 mm
BO 5207947	Inlay for BO 5207946 · 8.76; 10.76 mm



Shower Door Sealing Strips

The following page shows some suggested sealing strip positions. There are different seals configurations that can be used and this is intended as a guide only.

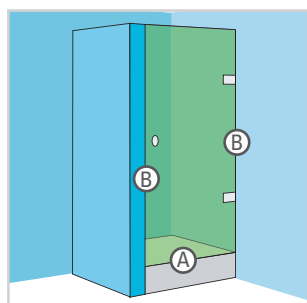

Type 1

For shower hinges with a 7 - 8 mm glass-wall gap.

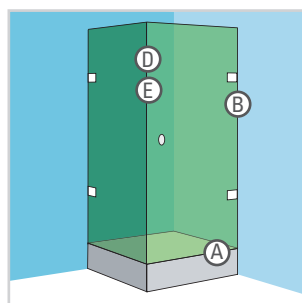

Type 6

For shower hinges with a 7 - 8 mm glass-wall gap.

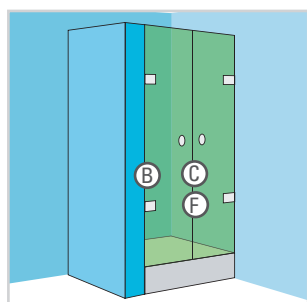

Type 2

For shower hinges with a 7 - 8 mm glass-wall gap.

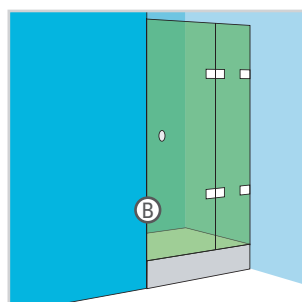

Type 7

For shower hinges with a 7 - 8 mm glass-wall gap.

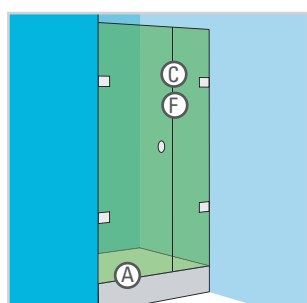

Type 3

For shower hinges with a 7 - 8 mm glass-wall gap.

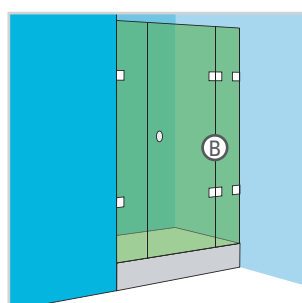

Type 8

For shower hinges with a 7 - 8 mm glass-wall gap.

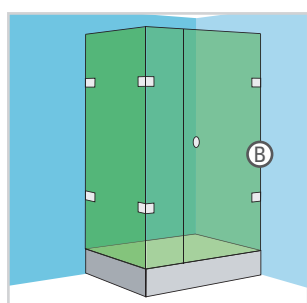

Type 4

For shower hinges with a 7 - 8 mm glass-wall gap.

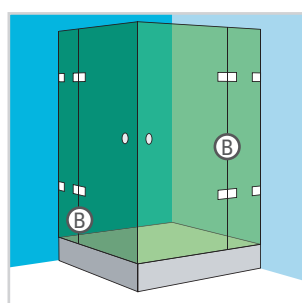

Type 9

For shower hinges with a 7 - 8 mm glass-wall gap.

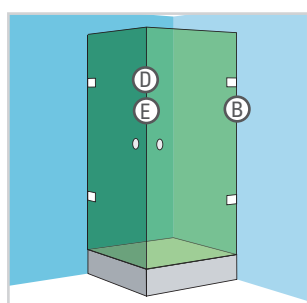

Type 5

For shower hinges with a 7 - 8 mm glass-wall gap.

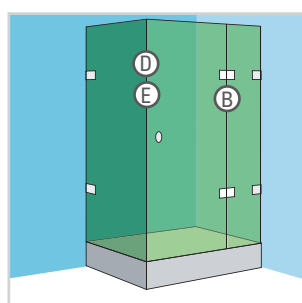

Type 10

For shower hinges with a 7 - 8 mm glass-wall gap.

Sealing Strip Glass thickness 6 - 8 mm, Type A

With lower sealing lip and 8 mm water deflector

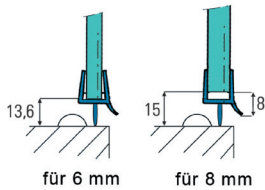

i Glass thickness 6 + 8 mm · Length 2160 mm · Material: plastic

Art. No.

BO 5213490

Sealing Strip Glass thickness 10 - 12 mm, Type A

With lower sealing lip and 8 mm water deflector

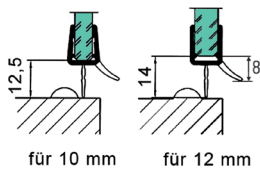

i Glass thickness 10 + 12 mm · Length 2160 mm · Material: plastic

Art. No.

BO 5281091

Sealing Strip Glass thickness 6 - 8 mm with bellows, Type B

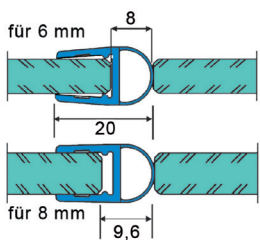

i With bellows · Glass thickness 6 + 8 mm · Length 2160 mm · Material: plastic

Art. No.

BO 5213517

Sealing Strip Glass thickness 10 - 12 mm with bellows, Type B

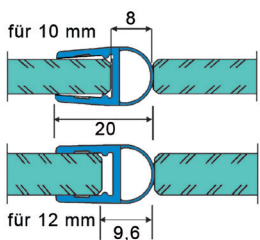

i With bellows · Glass thickness 10 + 12 mm · Length 2160 mm · Material: plastic

Art. No.

BO 5281020

Sealing Strip Glass thickness 6 - 8 mm Door aligned 180°, Type C

Seals between fixed panel and door

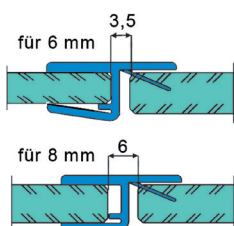

i Glass thickness 6 + 8 mm · Length 2160 mm · Door aligned 180 ° · Material: plastic

Art. No.

BO 5213518

Shower Door Sealing Strips

Bohle Sealing Strip Glass thickness 8 - 10 mm Door aligned 180°, Type C

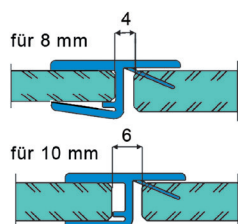

Seals between fixed panel and door

i Glass thickness 8 + 10 mm · Length 2160 mm · Door aligned 180° · Material: plastic

Art. No.

BO 5281018

Bohle Sealing Strip Glass thickness 6 - 8 mm Door / Fixed glazing 90°, Type D

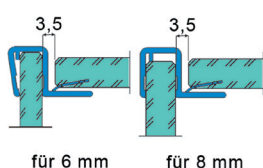

Seals between fixed panel and door

i Glass thickness 6 + 8 mm · Length 2160 mm · Door / Fixed glazing 90° · Material: plastic

Art. No.

BO 5213519

Bohle Sealing Strip Glass thickness 8 - 10 mm Door / Fixed glazing 90°, Type D

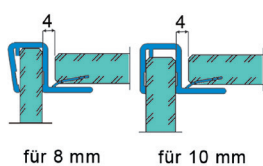

Seals between fixed panel and door

i Glass thickness 8 + 10 mm · Length 2160 mm · Door / Fixed glazing 90° · Material: plastic

Art. No.

BO 5281019

Bohle Sealing Strip Glass thickness 6 - 8 mm, magnetic profile for corner access 90°, Type E

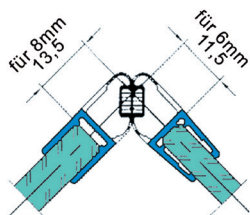

For corner access 90°

i With magnetic profile · Glass thickness 6 + 8 mm · Length 2160 mm · Material: plastic

Art. No.

BO 5213529

Bohle Sealing Strip Glass thickness 10 - 12 mm, magnetic profile for corner access 90°, Type E

For corner access 90°

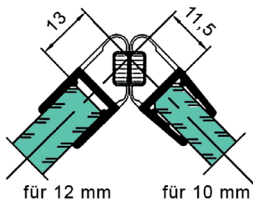

i With magnetic profile · Glass thickness 10 + 12 mm · Length 2160 mm · Material: plastic

Art. No.

BO 5281031

Bohle Sealing Strip for 6 - 8 mm glass, magnetic profile Door aligned 180°, Type F

i With magnetic profile · Door aligned 180° · Glass thickness 6 + 8 mm · Length 2160 mm · Material: plastic

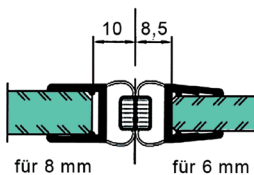

Art. No.

BO 5213530

Bohle Sealing Strip Glass thickness 10 - 12 mm with magnetic profile Door aligned 180°, Type F

i With magnetic profile · Door aligned 180° · Glass thickness 10 + 12 mm · Length 2160 mm · Material: plastic

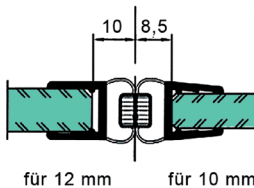

Art. No.

BO 5281032

Bohle Sealing Strip Glass thickness 6 - 8 mm with magnetic profile 135°

i With magnetic profile · Angle 135° · Glass thickness 6 + 8 mm · Length 2160 mm · Material: plastic

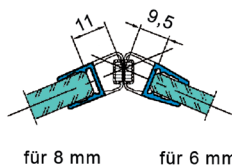

Art. No.

BO 5213515

Shower Door Sealing Strips

Bohle Sealing Strip Glass thickness 10 - 12 mm with magnetic profile 135°

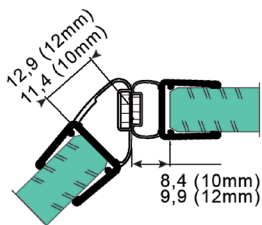

i With magnetic profile · Angle 135° · Glass thickness 10 + 12 mm · Length 2160 mm · Material: plastic

Art. No.

BO 5281016

Bohle Sealing Strip, glass-glass 180°, Glass thickness 6 mm

For glass / glass · overlapping 180° · for use with shower door hinges "Wave" BO 53 300 52 - 56

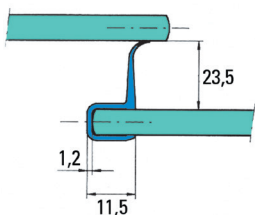

i Glass thickness 6 mm · Length 2200 mm · Material: plastic

Art. No.

BO 5213527

Bohle Sealing Strip, glass-glass 180°, Glass thickness 8 mm

For glass / glass · overlapping 180° · for use with shower door hinges "Wave" BO 53 300 52 - 56

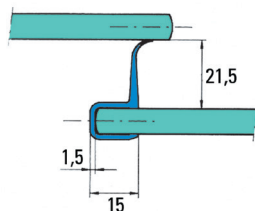

i Glass thickness 8 mm · Length 2200 mm · Material: plastic

Art. No.

BO 5213524

Bohle Sealing Strip Glass thickness 8 mm with sealing lip

With sealing lip · seals between glass edge and wall

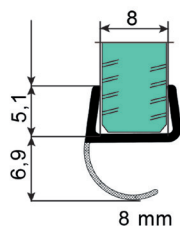

i Glass thickness 8 mm · Length 2160 mm · Material: plastic

Art. No.

BO 5213492

Bohle Sealing Strip Glass thickness 10 mm with sealing lip

With sealing lip · seals between glass edge and wall

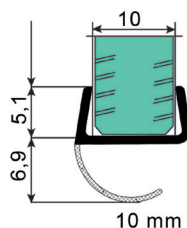

i Glass thickness 10 mm · Length 2160 mm · Material: plastic

Art. No.

BO 5281092

Sealing Strip Glass thickness 6 - 8 mm without lower sealing lip

With 8 mm water deflector · but without lower sealing lip

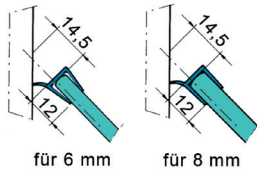

i Glass thickness 6 + 8 mm · Length 2160 mm · Material: plastic

Art. No.

BO 5213491

Sealing Strip Glass thickness 6 - 8 mm with lower sealing lip

With lower sealing lip

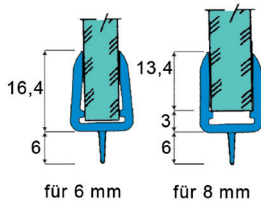

i Glass thickness 6 + 8 mm · Length 2160 mm · Material: plastic

Art. No.

BO 5213516

Sealing Strip, 2-Part Glass thickness 8 mm

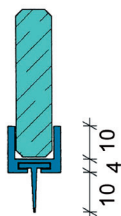

i Glass thickness 8 mm · Length 2485 mm · Material: plastic

Art. No.

BO 5213520

Sealing Strip Glass thickness 10 - 12 mm with water deflector

With water deflector

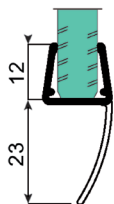

i Glass thickness 10 + 12 mm · Length 2160 mm · Material: plastic

Art. No.

BO 5281093

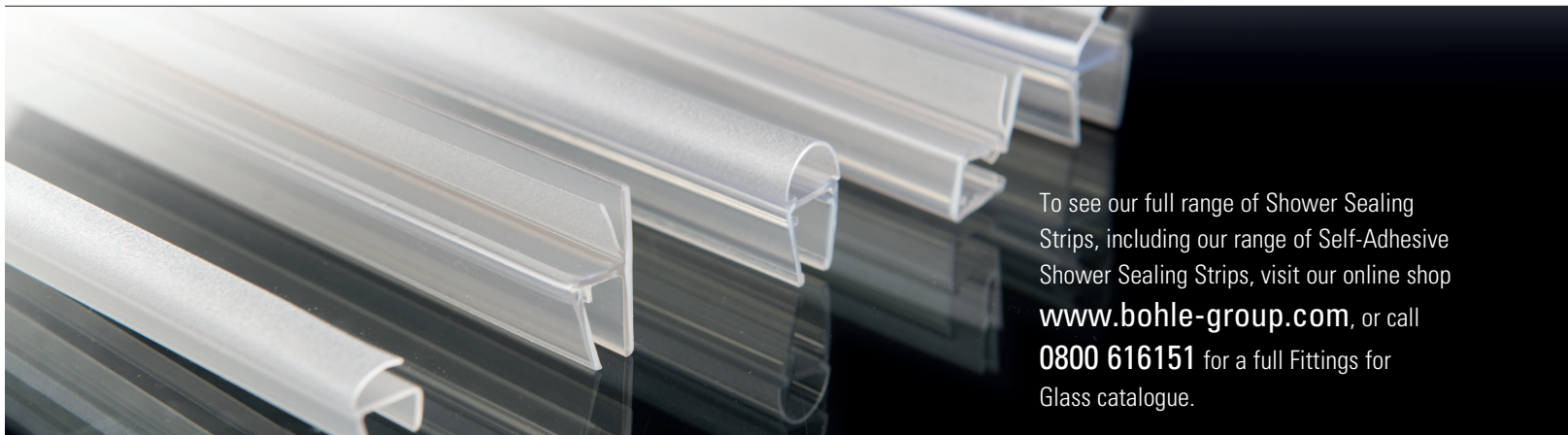

To see our full range of Shower Sealing Strips, including our range of Self-Adhesive Shower Sealing Strips, visit our online shop www.bohle-group.com, or call **0800 616151** for a full Fittings for Glass catalogue.

Thresholds

Threshold

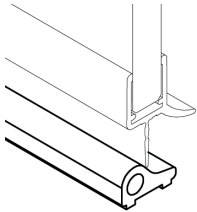

Non self-adhesive. Threshold must be fixed individually and on site.

i Length: 1800 mm

Art. No.	Finish
BK 6907031	shiny silver coloured
BK 6907082	pure white RAL 9010

Threshold end caps

Description: one each on the left and right sides

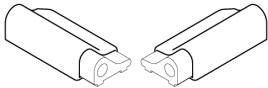

Art. No.	Finish
BK 6907331	shiny silver coloured
BK 6907382	pure white RAL 9010

Threshold acrylic

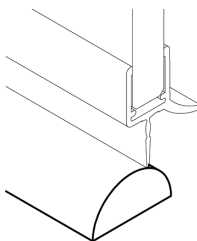

i Height 10 mm · Width 20 mm · Material acrylic · Colour transparent

Art. No.	Length
BK 69080	1000 mm
BK 69081	2000 mm

Threshold acrylic

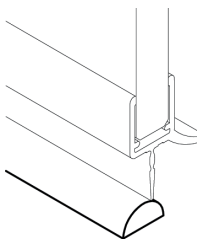

i Height 5 mm · Width 10 mm · Material acrylic · Colour transparent

Art. No.	Length
BK 69130	1000 mm
BK 69131	2000 mm

Basic round Reinforcement Bars

Easy to mount because the reinforcement bars can be trimmed to any desired length. No cut-outs or bore holes in the glass required. Glass holders are infinitely adjustable.

To see the full range of Basic round Reinforcement Bar fittings visit www.bohle-group.com, or phone 0800 616151 for a full Fittings for Glass catalogue.

Bohle Reinforcement Bar Bohle Basic round glass/wall



Bar can be trimmed to size

i Diameter 12 mm · Glass thickness 8-10 mm · Finish chrome-plated · Material brass

Art. No.	Description · Length
BO 5420065	glass/wall · 1210 mm

Bohle Reinforcement Bar Bohle Basic round glass/glass

Length adjustable



i Glass thickness 6—10 mm · Finish chrome-plated

Art. No.	Description · Length
BO 5420231	glass/glass · 750 - 1050 mm
BO 5420235	glass/glass · 1050 - 1350 mm



Premium round Reinforcement Bars

Well thought-out creation and design are the central focus of architecture. With its Premium products Bohle has succeeded in combining timeless elegance, aesthetics and freedom of movement with a blend of high-quality materials. The Premium round reinforcement bars have been specially designed for highly-frequented and barrier-free areas while maintaining their unobtrusive appearance. Made of polished stainless steel, the support bars fit harmoniously into any bathroom setting. To see the full range of Premium round Reinforcement Bar fittings visit www.bohle-group.com, or phone 0800 616151 for a full Fittings for Glass catalogue.

Bohle Reinforcement Bar Bohle Premium round glass/wall



i Diameter 18 mm · Glass thickness 8 - 10 mm · Material stainless steel mirror polished

Art. No.	Description · Length
BO 5420076	glass/wall · 1000 mm
BO 5420078	glass/wall · 1500 mm

Bohle Reinforcement Bar Bohle Premium round glass/glass



i Diameter 18 mm · Glass thickness 8 - 10 mm · Material stainless steel mirror polished

Art. No.	Description · Length
BO 5420072	glass/glass · 1000 mm
BO 5420074	glass/glass · 1500 mm



Basic square Reinforcement Bars

Timelessly modern. With Basic square, Bohle has achieved the perfect mix of form and function. The wide array of models enables almost any kind of customised construction project. Available in mirror polished and matt brushed stainless steel.

To see the full range of Basic square Reinforcement Bar fittings visit www.bohle-group.com, or phone 0800 616151 for a full Fittings for Glass catalogue.

Bohle Reinforcement Bar Bohle Basic square glass/wall straight

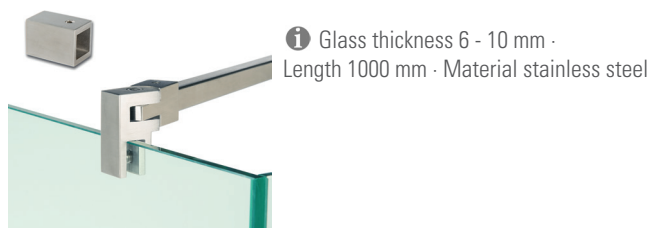

Art. No.	Description · Length
BO 5420240	glass/wall · matt brushed
BO 5420241	glass/wall · mirror polished

Bohle Reinforcement Bar Bohle Basic square glass/glass

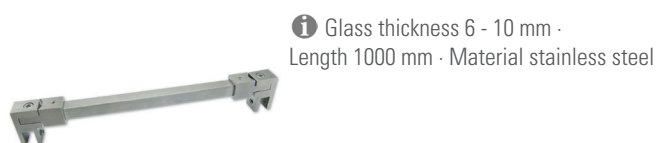

Art. No.	Description · Length
BO 5420236	glass/glass · matt brushed
BO 5420237	glass/glass · mirror polished



Premium square Reinforcement Bars

Less is more. Premium square achieves a perfect ratio of proportion, detail and material. Visible but unobtrusive. Premium square reinforcement bars captivate due to their clean straight lines. Minimalistic accentuation emphasizes the features of modern bathroom landscapes. The brass support bars can easily be trimmed to size.

To see the full range of Premium square Reinforcement Bar fittings visit www.bohle-group.com, or phone 0800 616151 for a full Fittings for Glass catalogue.

Reinforcement Bar Bohle Premium square glass/wall



i Glass thickness 8 - 10 mm glass · Length 1000 mm · Finish chrome-plated · Material brass

Art. No.	Description
BO 5420088	glass/wall

Reinforcement Bar Bohle Premium square glass/glass



i Glass thickness 8 - 10 mm glass · Length 1000 mm · Finish chrome-plated · Material brass

Art. No.	Description
BO 5420087	glass/glass







Doorknobs, Handles and Towel Holders for Showers



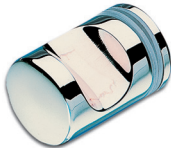

The large variety of knobs, handles and towel holders helps individualise your shower cubicle to your personal bathroom concept. Great value is attached to the choice of different materials, finishes, applications and shapes available.



Door Knobs and Handles for Glass - At a C

Door Knobs for Glass				
Art. no.	BO 5213725/26	BO 5213705 - 10	BO 5213715/16	BO 5213722
Stainless steel 1.304				
Brass	✓	✓	✓	✓
Aluminium		✓		
Glass				
Glass thickness (mm)	6 - 10	6 - 10	6 - 10	6 - 10
Drill hole (mm)	10	10	10	10



Door Knobs for Glass				
Art. no.	BO 5213771	BO 5206704	BK 0503031/55	BO 5206711-13
Stainless steel 1.304				
Brass	✓	✓	✓	✓
Aluminium				
Glass				
Glass thickness (mm)	4 - 8	6 - 10	8 - 10	6 - 12
Drill hole (mm)	8	12	12	10







Door Handles for Glass				
Art. no.	BO 5113720+, BO 5113738+	BO 5212510-15	BO 5212520-25	BO 5212505-07
Stainless steel 1.304	✓	✓	✓	✓
Brass				
Aluminium				
Glass				
Glass thickness (mm)		4 - 12	4 - 12	6 - 10
Drill hole (mm)		10	10	10
Self-adhesive	✓			

Glance



					
BO 5213781	BO 5206702-03 / BO 5206802	BO 5213700-02	BK 0501331	BK 0501531	BO 5213750-52
	✓		✓	✓	✓
✓	✓	✓			
6 - 10	6 - 8	6 - 10	6 - 12	6 - 12	6 - 10
12	12	16	14	14	12

	
BO 5206714-16	BO 5206717-19
✓	✓
6 - 12	6 - 12
10	10

					
BO 5213849	BO 5215023	BO 5215033-36	BO 5215024	BO 5215025	BO 5215026
✓	✓	✓	✓	✓	✓
6 - 8	6 - 12	6 - 12	6 - 12	6 - 12	6 - 12
14	12	12	14	12	14

BriteGuard® Smart surface protection

BriteGuard® is a registered brand of Bohle AG. For over 90 years we have been developing, producing and selling products for glass processing and finishing. No matter what you plan to do with glass, our full product range offers you the right products – including surface protection. With BriteGuard® Bohle has developed a surface protection system that is setting new standards. At the heart of the system are the two coating products BriteGuard® Surface SEALER for smooth surfaces and BriteGuard® Surface SEALER X for rough surfaces. The German Technical Inspection Agency, TÜV, has tested BriteGuard® Surface SEALER and confirmed that smooth glass surfaces become easy to clean and dirt-repellent when protected with BriteGuard® – typically for at least 10 years.

Bohle BriteGuard® Surface ACTIVATOR



For pre-cleaning smooth glass/glazed ceramic surfaces before applying Surface SEALER.

Art. No.	Description
BO 5831000	1 l

Bohle BriteGuard® Surface SEALER



Surface SEALER is suitable for all smooth glass or glazed ceramic surfaces. It makes no difference whether the coated material will be used indoors or outdoors or whether you want to protect showers, partitions, conservatories, facades or glass furniture.

Art. No.	Description
BO 5810500	500 ml
BO 5815000	5 l

Bohle BriteGuard® Surface FINISHER



For easy removal of excess material after applying Surface SEALER.

Art. No.	Description
BO 5841000	1 l

Bohle BriteGuard® Surface SEALER X



Surface SEALER X was specially developed for rough surfaces. This can be glass that is satin finished or sandblasted.

Art. No.	Description
BO 5820500	500 ml
BO 5825000	5 l

BriteGuard® Express

BO 5850050

Protect your showers quickly and easily before mounting with BriteGuard® Express. The coated glass surface is immediately protected and can be easily cleaned. In this way your customer will enjoy a high quality shower for a long time. Simply leave the remaining BriteGuard® Express with your customer after the first coating so that they can refresh the protection at any time. Once it is used up they can buy new material directly from you.

Benefits:

- Quick protection for all smooth glass surfaces
- Simple application - clean the glass pane, apply BriteGuard® Express uniformly with a spray bottle and polish.
- The surface becomes hydrophobic immediately (water drips off)
- The glass remains protected & easy to clean for several months
- Can be renewed at any time
- For professional requirements and for use at home
- 500 ml bottle with spray head



Products for Care and Maintenance

We recommend Bohle Premium Glass Cleaner for routine cleaning. If the coating has been damaged due to improper use at the end customer's site, it can be refreshed quickly and easily with our BriteGuard® REFRESHER Set for smooth glass and our BriteGuard® REFRESHER X Set for sandblasted glass.

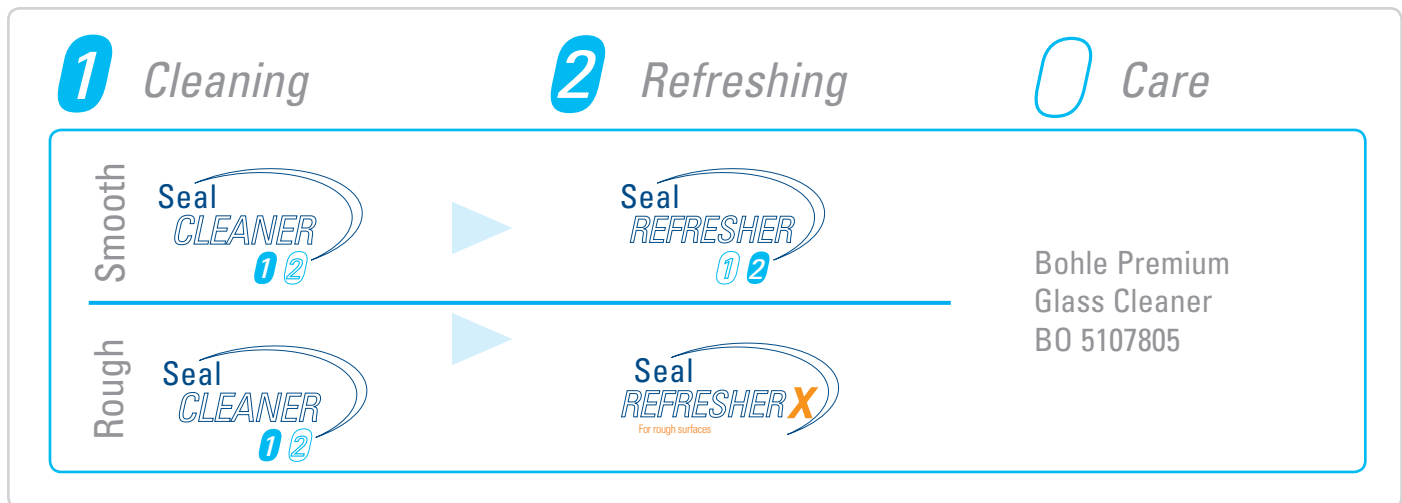

Bohle Seal REFRESHER Set



Seal CLEANER optimally prepares surfaces for treatment with Seal REFRESHER · Seal REFRESHER is used to refresh the functional layer of smooth surfaces when its effectiveness diminishes (for example when it has been handled improperly).

Included in delivery:
1x BriteGuard® Seal CLEANER, 250 ml
1x BriteGuard® Seal REFRESHER, 250 ml
1x Microfibre Cloth

Art. No.	
BO 5860250	Seal REFRESHER Set

Bohle Seal REFRESHER X Set



Seal CLEANER optimally prepares surfaces for treatment with Seal REFRESHER X · Seal REFRESHER X is suitable for refreshing the functional layer of rough surfaces.

Included in delivery:
1x BriteGuard® Seal CLEANER, 250 ml
1x BriteGuard® Seal REFRESHER X, 250 ml
1x Microfibre Cloth

Art. No.	
BO 5860251	Seal REFRESHER X Set

Limescale Remover

BriteGuard® Limescale Remover for professional use or standard use at home. Spray BriteGuard® Limescale Remover onto the surface and allow a short while to take effect before removing with a clean towel.

Benefits:

- Can be reapplied at any time
- 500 ml bottle with spray head
- Spray BriteGuard® Limescale Remover onto the surface and allow a short while to take effect before removing with a clean towel.
- Suitable for pre-cleaning before using BriteGuard® Express

Art. no.	Contents
BO 5880100	100 ml, sample bottle
BO 5880500	500 ml
BO 5885000	5 l





The Bohle Online Shop

The Bohle Online Shop offers you our latest product range around the clock in a clearly structured and informative way.

The brand new Online Shop has now been launched, featuring clearer layout, better performance and improved functionality.

www.bohle-group.com



Optimised for all digital devices.

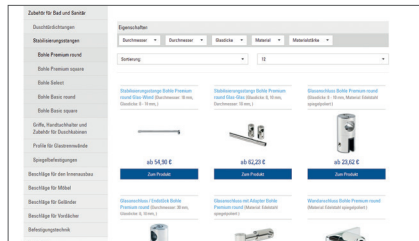

Clearly structured product presentation with filter function.

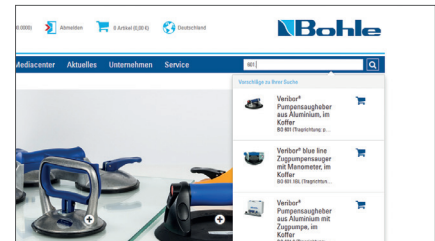

Convenient search function.

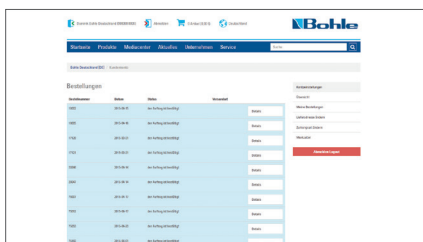

Secure customer area with online and offline order history.

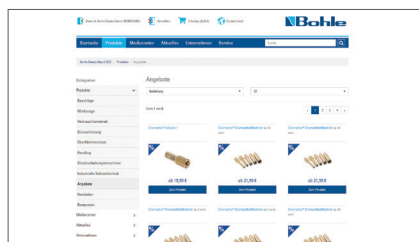

New offers and deals always updated.

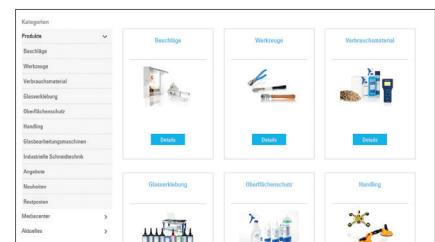

24/7 the latest product portfolio.

How to contact Bohle

Bohle Ltd.

Bohle Online Shop
Sales Telephone
Sales Fax
Machinery Sales & Support
Account Payments Direct
E-Mail
Pickup and Postal Address

www.bohle-group.com
0800 616151
0161 344 0111
0161 342 1104
0161 342 1112
info@bohle.ltd.uk
Fifth Avenue,
Tameside Park, Dukinfield
Cheshire SK16 4PP

Office opening times

Monday to Friday 8.00 am - 5.00 pm

Collection point opening times

Monday to Friday 9.00 am - 3.30 pm

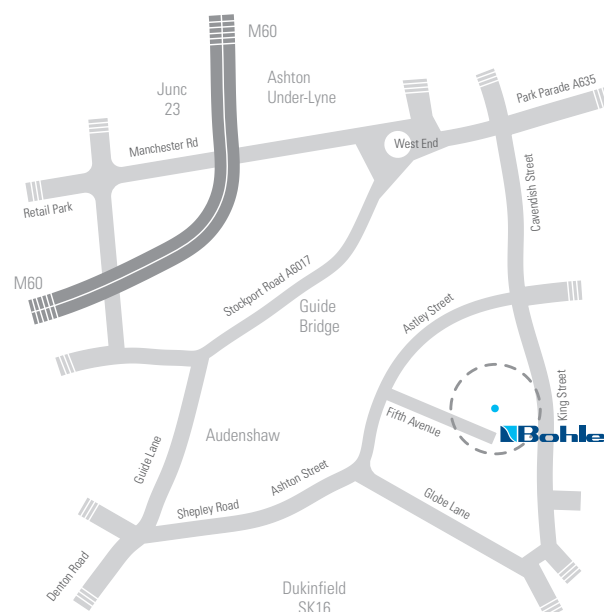

Notes about this catalogue

With the printing of this catalogue, all previous catalogues or parts thereof, are no longer valid. Our offers apply to retail, trade and industry. Technical specifications (dimensions, weights, materials, etc.) and other specifications (design, colour, etc.) are subject to change. The range of products can change during the time this catalogue is current. In particular, we reserve the right to remove individual articles without prior notice. Please request further details from your Bohle contact person. Print-related colour variations are possible. Bohle AG is not liable for any printing or other errors and omissions in this catalogue. For many of the articles protective rights such as patents, trademarks, design copyrights, etc. have been registered or are pending registration - also by third parties.

© Copyright by Bohle - This catalogue is protected in all parts (texts, photos, images etc.) by copyright. Any use outside the strict limits of copyright laws without written permission of Bohle AG is not permitted. This applies in particular to duplications, reprints, translations, microfilming as well as saving and processing in electronic systems.

United Kingdom and Ireland

Bohle Ltd.
Fifth Avenue
Tameside Park · Dukinfield
Cheshire · SK16 4PP

T +44 161 3421100
F +44 161 3440111

info@bohle.ltd.uk
